



O-Light II

CURING LIGHT

Instruction Manual

Please read this manual before operating

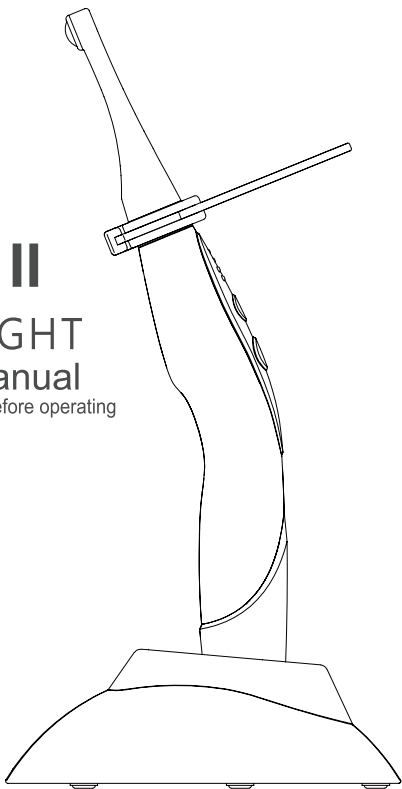

Contant

Preface-----	2
1. Introduction-----	2
2. Product Performance Structure and Components -----	2
3. Basic Technical Specifications -----	3
4. Installation and Demounting -----	4
5. Operation -----	4
6. Precaution -----	6
7. Cleaning, Disinfection and Sterilization -----	7
8. Contraindication -----	11
9. Daily maintenance -----	11
10. Troubleshooting -----	11
11. Storage and transportation -----	12
12. After service -----	12
13. Environmental protection -----	12
14. Symbol instruction -----	12
15. EMC - Declaration of conformity -----	13
16. Statement -----	16

Preface

Guilin Woodpecker Medical Instrument Co., Ltd. is a high-tech enterprise in researching, developing, and producing dental equipment, and has a perfect quality assurance system, main products including ultrasonic scaler, curing light, apex locator and ultrasurgery etc.

1. Introduction

1.1 Features:

1.1.1 Three working modes: Turbo Power, High Power and Standard Power

1.1.2 Time setting :

Turbo Power: 1S, 3S

High Power: 3S, 5S

Standard Power: 5S, 10S, 15S, 20S

1.1.3 Constant light intensity. The solidification effect is not affected by the consumption of remaining power.

1.1.4 Large capacity battery. A full charge can be used for more than 400 times continuously under 10s working time mode.

1.2 Principle and Application

1.2.1 Adopts the principle of ray radiation to solidify the light-sensitive resin by shooting at it in a short time.

1.2.2 This product is used for dentistry. It has the function of accelerating the material of dental restoration curing.

1.2.3 The user must be professionally trained and qualified dentists.

2. Product Performance Structure and Components

The curing light (dentistry) is mainly composed by LED, light hood, charging base, battery, adapter, main unit.

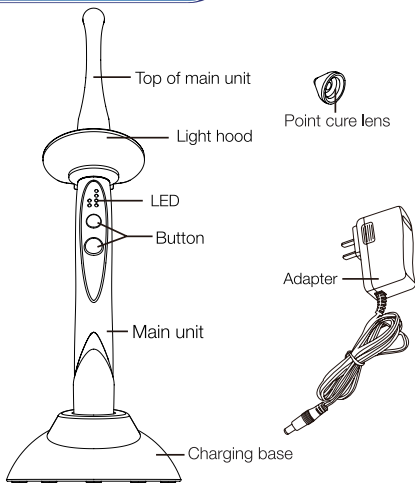

3. Basic Technical Specifications

3.1 Size: 268.8mm×26.1mm×31.8mm

3.2 Net weight: 259g

3.3 Applied parts of the equipment: Top of main unit, Point cure lens

3.4 Duty cycle of the equipment: 20 Sec on/20 Sec off

3.5 The components of machine(Packing list):

- | | | |
|----------------------------|--------------------------|--------------------|
| 1.Maint unit *1 | 2.Top of main unit *1 | 3.Light hood *1 |
| 4.Bathymeter *1 | 5.Adapter *1 | 6.Charging base *1 |
| 7.Point cure lens *1 | 8.Disposable sleeve *50 | |
| 9.Qualified certificate *1 | 10.Instruction manual *1 | |
| 11. Warranty card *1 | | |

3.6 Adapter:

3.6.1 classified by power supply

The power supply by the rechargeable battery.

3.6.2 Rechargeable Lithium battery:

Battery model:18500, Battery capacity: 2000mAh

Battery has over-voltage, over current and short circuit protection

3.6.3 Adapter(charge)

Input: 100-240V~ 50/60Hz 0.4A Max.

Output: 5.0V --- 1A

The adapter must be complies with IEC 60601-1 and IEC 60601-1-2.

3.7 Light source:

3.7.1 10W high power

3.7.2 Wave length: 385nm~515nm

3.7.3 Class: class I

3.7.4 AEL: 3.9×10^{-3} J

3.7.5 Check method: When operate machine properly, LED luminous means LED is in good condition.

3.7.6 The wavelength of our curing light machine can match with dental resin material which are commonly used on clinical, such as 3M and Dentsply.

3.7.7 440 nm to 490 nm (blue light) wavelength range of radiation: not less than 250 mw/cm².

3.7.8 Work condition:

Environment temperature: +5°C to +40°C

Relative humidity: 30%~75%

Atmosphere pressure: 70kPa to106kPa

3.8 Safety classification

3.8.1 Protection type against electrical shock: Class II

3.8.2 Protection degree against electrical shock: Type B

3.8.3 Protection against harmful ingress of water or particular matter: ordinary equipment (IPX0), can't be waterproof.

3.8.4operation mode: short time run equipment.

3.8.5 Safety in the presence of flammable anesthetic mixture with air, oxygen or nitrous oxide: not suitable under this condition.

4. Installation and Demounting

4.1 Aim the mounting holes which on the upper of machine ,and make the long side of top of the main unit inserted to it (must screw the top of the main unit to the end, don't inclined inserted).

4.2 When the battery needs to be charged, connect the plug of the adapter into the AC100V~240V power supply. Then connect the output plug of the adapter to the DC 5V input plug of the pedestal, then put the main unit into the pedestal. Please pull out the adapter after charging.

5. Operation

5.1. Press and hold "M/T" Button for 2 seconds and release, the curing light will cycle to next Mode. Following three modes are available.

5.1.1 Turbo Power Mode: Press and release "M/T" Button quickly to cycle through time options which could be 1 and 3 seconds. Its output light intensity is about 2700-3000 mW/cm².

5.1.2 High Power Mode: Press and release "M/T" Button quickly to cycle through time options which could be 3 and 5 seconds. Its output light intensity is about 1800-2000 mW/cm².

5.1.3 Standard Power Mode: Press and release "M/T" Button quickly to cycle through time options which could be 5, 10, 15 and 20 seconds. Its output light intensity is about 1000-1200 mW/cm².

5.2 Quick mode guide

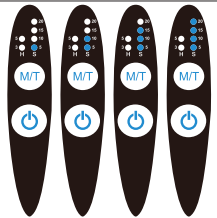
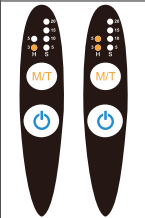
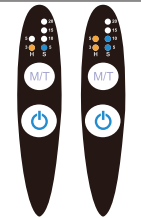
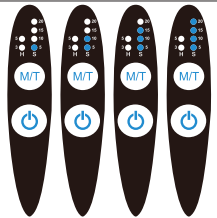
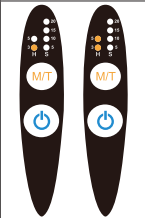
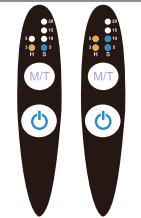
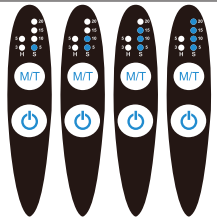
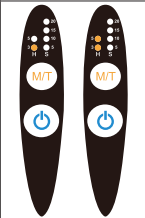
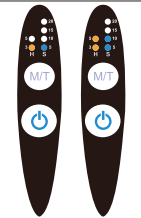
Mode	Standard Power 1000-1200mW/cm ²	High Power 1800-2000mW/ cm ²	Turbo Power 2700-3000mW/ cm ²
Mode/Timing LEDs			
Mode/Time Change Button			
Power Button			
Time Options	5s 10s 15s 20s	3s 5s	1s 3s
To Change Time	Press and release "M/T" Button quickly to cycle through time options.		
To Change Modes	Press and hold "M/T" Button for 2 seconds and release. Curing light will cycle to next Mode.		
Light intensity	Light intensity will vary based on instrument capability, measurement method and light placement. Standard Power: 1000-1200mW/cm ² , measured by a IVOCLAR VIVADENT® Bluephase® Meter II radiometer. High Power: 1800-2000mW/cm ² , measured by a IVOCLAR VIVADENT® Bluephase® Meter II radiometer. Turbo Power: 2700-3000mW/cm ² , measured by a spectrum analyzer.		

5.3 Quick Curing Guide: Recommended Curing Times for Optimal Results with O-Light II curing light

Exposure times may need to be adjusted due to composite reactivity, shade, distance from the light lens to the composite, and depth of composite layer if it is over 2mm.

Mode	Standard Power	High Power	Turbo Power
Per 2mm Layer	1×10 Seconds	2×3 Seconds	1×3 Seconds
Final Cure	2×10 Seconds	3×3 Seconds	2×3 Seconds
Ortho Metal & Ceramic Brackets	2×10 Seconds	2×5 Seconds	2×3 Seconds

5.4 Use Point Cure Lens: The magnetic Point Cure Lens provides pinpoint curing of small composites and is helpful for tack curing veneers and all porcelain crowns.

For veneers, the Turbo Power mode with a 1-second timing interval allows for point curing the center of a veneer with the ability to then clean up the uncured excess around the margins, then cure the entire restoration using the full-sized curing lens.

For all porcelain crowns, place the curing light on the buccal and lingual surfaces and point cure using Turbo Power mode for approximately 2 seconds each, clean up the uncured resin around the margins, then cure the entire restoration using the full-sized lens.

5.5 When operating, aim the top of the main unit at the correct position, press the power button, a “di” sound will appear, the LED shine the blue light and start to work under the selected mode. Screen began to display the countdown time. When the countdown back to 0 the work finished. Then the screen will return to setting time.

5.6 While operation, press the power switch button can stop work at any time.

5.7 At the end of a working cycle, the next working cycle can be started immediately by short pressing the button. If the main unit gets hot obviously, please turn off the device until the main unit becomes cool. Please don't make it continuously illuminate more than 10 times.

5.8 Low power detect circuit is fixed inside of the main unit, when low power is detected, the battery symbol display LED flashing, please charge in time.

5.9 Connect the power adapter with the charging base. Place the main unit into the charging base, confirm that pressing out the buckle between the main unit, and then if the indicator light on charging base turns yellow, it indicates that it is charging. If the indicator light on base turns green, it indicates that the battery capacity is enough, and there is no need to charge.

5.10 When operating finish, please clean the top of the main unit with calico to avoid infecting the light intensity.

5.11 This equipment will turn off automatically if don't any action within 2 minutes, turn it on by press power button.

5.12 The effective light intensity of this equipment is much more higher than Halogen Lamp, The solidified depth of the curing light composites resin for 10 seconds will not less than 4mm.

WARNING

Wear a disposable sleeve before using the equipment on the patient.

The disposable sleeve has been disinfected with ethylene oxide. Unless the package is opened, there will be no bacterial. If the sealing tape is damaged, please do not use.

6. Precaution

6.1 Please recharge the battery at least 4 hours before first time usage.

6.2 The adapter plug is used as the isolation from the SUPPLY MAINS. When charging the battery, please not to position the device so that it is difficult to operate the disconnection device.

6.3 During operation, the light should be aimed straightly at the resin to ensure the effect of solidification.

6.4 Be sure to use the original light hood to avoid the blue light hurt eyes. Prohibit aiming light at eyes directly.

6.5 Only the original adapter could be used, because other brand adapters are likely to damage the circuit.

6.6 It is forbidden to use metal or other conductors to touch the charging point of main unit, because it may burn the internal circuit or make the lithium short circuit.

6.7 Charging the battery in the condition of cool and ventilated. Please make sure of pressing out the buckle between the main unit and the pedestal, otherwise the battery charging might be failed because of the poor contact.

6.8 Do not disassemble the Lithium battery, it will lead to the circuit short or the electrolyte leakage.

6.9 Do not squeeze, shake and short the battery, do not store the battery with metal material.

6.10 The instrument has electromagnetic interference. Do not use around the electronic operation, at the same time have a strong electromagnetic interference environment should be careful to use the instrument.

6.11 It is forbidden to use when charging or operation.

6.12 This product should be used by trained, qualified dentists. And this product is suitable for dental patients. Must be use in hospital or professional medical site.

6.13 To avoid electromagnetic interference, the device should be installed at the medical site which meet the requirement of EMC.

WARNING: The adapter should be connected to the socket which is easy for operator to touch.

WARNING: over-heat scorching: The duty cycle of the equipment is 20 Sec on/20 Sec off, if the curing light works for 40s continuously, the temperature of the top of main unit may reach 56 C .

WARNING: parts of the ME equipment that are not serviced or maintained while in use with the patient.

7. Cleaning, Disinfection and Sterilization

The cleaning, disinfection and sterilization of Point cure lens is as follow.

Unless otherwise stated, they will be hereinafter referred to as “products”.

Warnings

The use of strong detergent and disinfectant (alkaline pH>9 or acid pH <5) will reduce the life span of products. And in such cases, the manufacturer takes no responsibility.

This device shall not be exposed to high temperature above 138°C.

Processing limit

The products have been designed for a large number of sterilization cycles.

The materials used in manufacture were selected accordingly. However with every renewed preparation for use, thermal and chemical stresses will result in ageing of the products. The maximum number of sterilizations for optical fiber is 500 times.

7.1 Initial processing

7.1.1 Processing principles

It is only possible to carry out effective sterilization after the completion of effective cleaning and disinfection. Please ensure that, as part of your responsibility for the sterility of products during use, only sufficiently validated equipment and product-specific procedures are used for cleaning/disinfection and sterilization, and that the validated parameters are adhered to during every cycle.

Please also observe the applicable legal requirements in your country as well as the hygiene regulations of the hospital or clinic, especially with regard to the additional requirements for the inactivation of prions.

7.1.2 Post-operative treatment

The post-operative treatment must be carried out immediately, no later than 30 minutes after the completion of the operation. The steps are as follows:

1. Remove the optical fiber from the Curing light Device, and rinse away the dirt on the surface of product with pure water (or distilled water/deionized water);
2. Dry the product with a clean, soft cloth and place it in a clean tray.

Notes

- a) The water used here must be pure water, distilled water or deionized water.

7.2 Preparation before cleaning

Steps

Tools: tray, soft brush, clean and dry soft cloth Remove optical fiber from main unit and put it into the clean tray.

Use a clean soft brush to carefully brush the optical fiber until the dirt on surface is not visible. Then use soft cloth to dry the optical fiber and put them into a clean tray. The cleaning agent can be pure water, distilled water or deionized water.

7.3 Cleaning

The cleaning should be performed no later than 24 hours after the operation.

The cleaning can be divided into automated cleaning and manual cleaning. Automated cleaning is preferred if conditions permit.

7.3.1 Automated cleaning

•The cleaner is proved to be valid by CE certification in accordance with ENISO 15883.

•There should be a flushing connector connected to the inner cavity of the product.

•The cleaning procedure is suitable for the product, and the irrigating period is sufficient.

It is recommended to use a washer-disinfector in accordance with EN ISO15883. For the specific procedure, please refer to the automated disinfection section in the next section "Disinfection".

Notes

a) The cleaning agent does not have to be pure water. It can be distilled water, deionized water or multi-enzyme. But please ensure that the selected cleaning agent is compatible with the product.

b) In washing stage, the water temperature should not exceed 45 °C, otherwise the protein will solidify and it would be difficult to remove.

c) After cleaning, the chemical residue should be less than 10mg / L.

7.4 Disinfection

Disinfection must be performed no later than 2 hours after the cleaning phase.

Automated disinfection is preferred if conditions permit.

7.4.1 Automated disinfection-Washer-disinfector

•The washer-disinfector is proved to be valid by CE certification in accordance with EN ISO 15883..

•Use high temperature disinfection function. The temperature does not exceed 134 °C, and the disinfection under the temperature cannot exceed 20 minutes.

•The disinfection cycle is in accordance with the disinfection cycle in EN ISO 15883.

Cleaning and disinfecting steps by using Washer-disinfector

1. Carefully place the product into the disinfection basket. Fixation of product is needed only when the product is removable in the device. The products are not allowed to contact each other.

2. Use a suitable rinsing adaptor, and connect the internal water lines to the rinsing connection of the washer-disinfector.

3. Start the program.

4. After the program is finished, remove the product from the washer-disinfector,

inspect (refer to section “Inspection and Maintenance”) and packaging (refer to chapter “Packaging”). Dry the product repeatedly if necessary (refer to section “Drying”).

Notes

a) Before use, you must carefully read the operating instructions provided by the equipment manufacturer to familiarize yourself with the disinfection process and precautions.

b) With this equipment, cleaning, disinfection and drying will be carried out together.

c) Cleaning: (c1) The cleaning procedure should be suitable for the product to be treated. The flushing period should be sufficient (5-10 minutes). Pre-wash for 3 minutes, wash for another 5 minutes, and rinse it for twice with each rinse lasting for 1 minute. (c2) In the washing stage, the water temperature should not exceed 45 °C, otherwise the protein will solidify and it is difficult to remove. (c3) The solution used can be pure water, distilled water, deionized water or multi-enzyme solution, etc., and only freshly prepared solutions can be used. (c4) During the use of cleaner, the concentration and time provided by manufacturer shall be obeyed.

The used cleaner is neodisher MediZym (Dr. Weigert).

d) Disinfection: (d1) Direct use after disinfection: temperature ≥ 90 °C, time ≥ 5 min or A0 ≥ 3000 .

(d2) Sterilize it after disinfection and use: temperature ≥ 90 °C, time ≥ 1 min or A0 ≥ 600 .

(d3) For the disinfection here, the temperature is 93 °C, the time is 2.5 min, and A0 > 3000.

e) Only distilled or deionized water with a small amount of microorganisms (<10 cfu/ml) can be used for all rinsing steps. (For example, pure water that is in accordance with the European Pharmacopoeia or the United States Pharmacopoeia).

f) After cleaning, the chemical residue should be less than 10mg / L.

g) The air used for drying must be filtered by HEPA.

h) Regularly repair and inspect the disinfectant.

7.5 Drying

If your cleaning and disinfection process does not have an automatic drying function, dry it after cleaning and disinfection.

Methods

1. Spread a clean white paper (white cloth) on the flat table, point the product against the white paper (white cloth), and then dry the product with filtered dry compressed air (maximum pressure 3 bar). Until no liquid is sprayed onto the white paper (white cloth), the product drying is completed.

2. It can also be dried directly in a medical drying cabinet (or oven). The recommended drying temperature is 80°C~120°C and the time should be 15~40 minutes.

Notes

a) The drying of product must be performed in a clean place.

b) The drying temperature should not exceed 138 °C;

c) The equipment used should be inspected and maintained regularly.

7.6 Inspection and maintenance

In this chapter, we only check the appearance of the product. After inspection, if there is no problem, the optical fiber can only be used.

7.6.1 Check the product. If there is still visible stain on the product after cleaning/disinfection, the entire cleaning/disinfection process must be repeated.

7.6.2 Check the product. If it is obviously damaged, smashed, detached, corroded or bent, it must be scrapped and not allowed to continue to be used.

7.6.3 Check the product. If the accessories are found to be damaged, please replace it before use. And the new accessories for replacement must be cleaned, disinfected and dried.

7.6.4 If the service time (number of times) of the product reaches the specified service life (number of times), please replace it in time.

7.7 Packaging

Install the disinfected and dried product and quickly package it in a medical sterilization bag (or special holder, sterile box).

Notes

- a) The package used conforms to ISO 11607;
- b) It can withstand high temperature of 138 °C and has sufficient steam permeability;
- c) The packaging environment and related tools must be cleaned regularly to ensure cleanliness and prevent the introduction of contaminants;
- d) Avoid contact with parts of different metals when packaging.

7.8 Sterilization

Use only the following steam sterilization procedures (fractional pre-vacuum procedure*) for sterilization, and other sterilization procedures are prohibited:

1. The steam sterilizer complies with EN13060 or is certified according to EN 285 to comply with EN ISO 17665;
2. The highest sterilization temperature is 138 °C;
3. The sterilization time is at least 4 minutes at a temperature of 132°C/134°C and a pressure of 2.0 bar ~ 2.3 bars.
4. Allow a maximum sterilization time of 20 minutes at 134 °C.

Verification of the fundamental suitability of the products for effective steam sterilization was provided by a verified testing laboratory.

Notes

- a) Only products that have been effectively cleaned and disinfected are allowed to be sterilized;
- b) Before using the sterilizer for sterilization, read the Instruction Manual provided by the equipment manufacturer and follow the instructions.
- c) Do not use hot air sterilization and radiation sterilization as this may result in damage to the product;
- d) Please use the recommended sterilization procedures for sterilization. It is not recommended to sterilize with other sterilization procedures such as ethylene oxide, formaldehyde and low temperature plasma sterilization. The manufacturer assumes no responsibility for the procedures that have not been recommended.

If you use the sterilization procedures that have not been recommended, please adhere to related effective standards and verify the suitability and effectiveness.

* Fractional pre-vacuum procedure = steam sterilization with repetitive pre-vacuum. The procedure used here is to perform steam sterilization through three pre-vacuums.

7.9 Storage

7.9.1 Store in a clean, dry, ventilated, non-corrosive atmosphere with a relative humidity of 10% to 93%, an atmospheric pressure of 70KPa to 106KPa, and a temperature of -20 °C to +55 °C;

7.9.2 After sterilization, the product should be packaged in a medical sterilization bag or a clean sealing container, and stored in a special storage cabinet. The storage time should not exceed 7 days. If it is exceeded, it should be reprocessed before use.

Notes:

- a) The storage environment should be clean and must be disinfected regularly;
- b) Product storage must be batched and marked and recorded.

7.10 Transportation

1. Prevent excessive shock and vibration during transportation, and handle with care;

2. It should not be mixed with dangerous goods during transportation.

3. Avoid exposure to sun or rain or snow during transportation.

The cleaning and disinfection of main unit are as follows.

- Before each use, wipe the surface of the machine with a soft cloth or paper towel soaked in 75% medical alcohol. Repeat the wipe for at least 3 times.

- After each use, wipe the surface of the device with a soft cloth soaked in clean water (distilled or deionized water) or a clean disposable wipe.

Repeat the wipe for at least 3 times.

8. Contraindication

The heart disease patients, pregnant women and children should be cautious to use this equipment.

9. Daily maintenance

9.1 This equipment does not include the self-maintainable spare parts. The maintenance of this equipment should be taken by the appointed professional or special repair shop.

9.2 Please use accessory which is designed and supplied by our company, contract with the local dealer or our company if you want to buy. It may cause potential dangers to curing light or other damages which is designed and supplied by other manufacturers.

9.3 The accessory of the product should be cleaned by clean water or sterilized liquid. Do not soak.

9.4 Please clean the resin remained on the top of the main unit after using to avoid infecting the life-span or solidified effect.

9.5 If the main unit not used for a long time, be sure to charge the lithium battery of the main unit every six months to prevent damage to the lithium battery after long-term storage.

10. Troubleshooting

Faults	Possible causes	Solutions
No indication No response.	1. Battery is out of power. 2. Battery is protected. 3. Faulty of battery.	1. Charging. 2. Please put the curing light into the pedestal for charging, then the battery works again. 3. Please contact our special repair shop or us.

Light intensity is weak.	There is resin on the top of the top of the main unit.	<ol style="list-style-type: none"> 1. Clean the resin. 2. Change a new top of the main unit.
The equipment doesn't charge when the adapter is connected.	<ol style="list-style-type: none"> 1. The adapter is not connected well 2. The charging point is impurity. 3. Faulty of adapter or incompatible. 	<ol style="list-style-type: none"> 1. Reconnect. 2. Clean by the alcohol. 3. Please contact our special repair shop or us.
Effective duration of the battery become short.	The capacity of the battery decreased.	Please contact our special repair shop or us.
The Display LED twinkles when charging.	low voltage.	Back to normal after 15 minuets charging.

If all the above solutions have been completed, the machine still can not work normally. Please contact our special repair shop or us.

11. Storage and transportation

11.1 The equipment should be handled carefully and lightly, kept away from the shaking source, installed or stored at shadowy, dry, cool and ventilated places.

11.2 Don't store the equipment together with articles that are combustible, poisonous, caustic, and explosive.

11.3 This equipment should be stored in the environment where the humidity is 10%~93%, the atmosphere pressure is 70kPa~106kPa and the temperature is -20℃~+55℃.

11.4 Excess impact or shake should be prevented during transportation. Handle with care.

11.5 Don't put it together with dangerous articles during transportation.

11.6 Keep it away form the sun, rain or snow during transportation.

12. After service

From the date this equipment has been sold, base on the warranty card, we will repair this equipment free of charge if it has quality problems, please refer to the warranty card for the warranty period.

13. Environmental protection

There are no harmful factors in our product. You can deal with it based on the local law.













14. Symbol instruction



Check the random file



Screw inside/outside

	Type B applied part	IPX0	Ordinary equipment
	Date of manufacture		Manufacturer
	Class II equipment		Used indoor only
	Follow Instructions for Use		Appliance compliance WEEE directive
	Atmospheric pressure for storage		Temperature limitation for storage
	Humidity limitation for storage		CE marked product
	Authorised Representative in the EUROPEAN COMMUNITY		

15. EMC - Declaration of conformity

The device has been tested and homologated in accordance with EN 60601-1-2 for EMC. This does not guarantee in any way that this device will not be effected by electromagnetic interference. Avoid using the device in high electromagnetic environment.

Guidance and manufacturer's declaration - electromagnetic emissions		
The device are intended for use in the electromagnetic environment specified below. The customer or the user of the device should assure that it is used in such an environment.		
Emissions test	Compliance	Electromagnetic environment - guidance
RF emissions CISPR 11	Group 1	The device use RF energy only for its internal function. Therefore, its RF emissions are very low and are not likely to cause any interference in nearby electronic equipment. The device are suitable for used in domestic establishment and in establishment directly connected to a low voltage power supply network which supplies buildings used for domestic purposes.
RF emissions CISPR11	Class B	
Harmonic emissions IEC 61000-3-2	Class A	
Voltage fluctuations / flicker emissions IEC 61000-3-3	Complies	

Guidance & Declaration — electromagnetic immunity

The device are intended for use in the electromagnetic environment specified below. The customer or the user of the device should assure that It is used in such an environment.

Immunity test	IEC 60601 test level	Compliance level	Electromagnetic environment - guidance
Electrostatic discharge (ESD) IEC 61000-4-2	± 8 kV contact ± 2 kV, ± 4 kV, ± 8 kV, ± 15 kV air	± 8 kV contact ± 2 kV, ± 4 kV, ± 8 kV, ± 15 kV air	Floors should be wood, concrete or ceramic tile. If floors are covered with synthetic material, the relative humidity should be at least 30 %.
Electrical fast transient/burst IEC 61000-4-4	± 2 kV for power supply lines ± 1 kV for Input/output lines	± 2 kV for power supply lines ± 1 kV for interconnecting cable	Mains power quality should be that of a typical commercial or hospital environment.
Surge IEC 61000-4-5	± 1 kV line to line ± 2 kV line to earth	± 1 kV line to line	Mains power quality should be that of a typical commercial or hospital environment.
Voltage dips, short interruptions and voltage variations on power supply input lines IEC 61000-4-11.	< 5 % UT (> 95 % dip in UT.) for 0.5 cycle 40 % UT (60% dip in UT) for 5 cycles 70% UT (30% dip in UT) for 25 cycles < 5 % UT (> 95 % dip in UT) for 5 sec	< 5 % UT (> 95 % dip in UT.) for 0.5 cycle 40 % UT (60% dip in UT) for 5 cycles 70% UT (30% dip in UT) for 25 cycles < 5 % UT (> 95 % dip in UT) for 5 sec	Mains power quality should be that of a typical commercial or hospital environment. If the user of the device require continued operation during power mains interruptions, it is recommended that the device be powered from an uninterruptible power supply or a battery.
Power frequency (50/60 Hz) magnetic field IEC 61000-4-8	30A/m	30A/m	Power frequency magnetic fields should be at levels characteristic of a typical location in a typical commercial or hospital environment.

NOTE UT is the a.c. mains voltage prior to application of the test level.

Guidance & Declaration - Electromagnetic immunity

The device are intended for use in the electromagnetic environment specified below. The customer or the user of the device should assure that it is used in such an environment.

Immunity test	IEC 60601 test level	Compliance level	Electromagnetic environment - guidance
<p>Conducted RF IEC 61000-4-6</p> <p>Radiated RF IEC 61000-4-3</p>	<p>3 Vrms 150 kHz to 80 MHz</p> <p>6 Vrms in ISM bands</p> <p>3 V/m 80 MHz to 2.7 GHz</p> <p>385MHz-5785MHz Test specifications for ENCLOSURE PORT IMMUNITY to RF wireless communication equipment (Refer to table 9 of IEC 60601-1-2:2014)</p>	<p>3 Vrms 150 kHz to 80 MHz</p> <p>6 Vrms in ISM bands</p> <p>3 V/m 80 MHz to 2.7 GHz</p> <p>385MHz-5785MHz Test specifications for ENCLOSURE PORT IMMUNITY to RF wireless communication equipment (Refer to table 9 of IEC 60601-1-2:2014)</p>	<p>Portable and mobile RF communications equipment should be used no closer to any part of the device, including cables, than the recommended separation distance calculated from the equation applicable to the frequency of the transmitter. Recommended separation distance</p> <p>$d = [3,5/\sqrt{P}] \times P^{1/2}$</p> <p>$d = 1.2 \times P^{1/2}$ 80 MHz to 800 MHz</p> <p>$d = 2.3 \times P^{1/2}$ 800 MHz to 2.5 GHz</p> <p>where P is the maximum output power rating of the transmitter in watts (W) according to the transmitter manufacturer and d is the recommended separation distance in meters (m).</p> <p>Field strengths from fixed RF transmitters, as determined by an electromagnetic site survey,^a should be less than the compliance level in each frequency range.^b</p> <p>Interference may occur in the vicinity of equipment marked with the following symbol:</p> 

NOTE 1 At 80 MHz end 800 MHz. the higher frequency range applies.

NOTE 2 These guidelines may not apply in all situations. Electromagnetic propagation is affected by absorption and reflection from structures, objects and people.

^a Field strengths from fixed transmitters, such as base stations for radio (cellular/cordless) telephones and land mobile radios, amateur radio, AM and FM radio broadcast and TV broadcast cannot be predicted theoretically with accuracy. To assess the electromagnetic environment due to fixed RF transmitters, an electromagnetic site survey should be considered. If the measured field strength in the location in which the device are used exceeds the applicable RF compliance level above, the model should be observed to verify normal operation. If abnormal performance is observed, additional measures may be necessary, such as reorienting or relocating the device.

^b Over the frequency range 150 kHz to 80 MHz, field strengths should be less than 3V/m.

Recommended separation distances between portable and mobile RF communications equipment and the device

The device are intended for use in electromagnetic environment in which radiated RF disturbances is controlled. The customer or the user of the device can help prevent electromagnetic interference by maintaining a minimum distance between portable and mobile RF communications equipment (transmitters) and the device are recommended below, according to the maximum output power of the communications equipment.

Rated maximum output power of transmitter W	Separation distance according to frequency of transmitter /m		
	150kHz to 80MHz $d=1.2 \times P^{1/2}$	80MHz to 800MHz $d=1.2 \times P^{1/2}$	800MHz to 2,5GHz $d=2.3 \times P^{1/2}$
0.01	0.12	0.12	0.23
0.1	0.38	0.38	0.73
1	1.2	1.2	2.3
10	3.8	3.8	7.3
100	12	12	23

For transmitters rated at a maximum output power not listed above, the recommended separation distance d in meters (m) can be estimated using the equation applicable to the frequency of the transmitter, where P is the maximum output power rating of the transmitter in watts (W) accordable to the transmitter manufacturer.

NOTE 1 At 80 MHz and 800 MHz. the separation distance for the higher frequency range applies. NOTE 2 These guidelines may not apply in all situations. Electromagnetic propagation is affected by absorption and reflection from structures, objects and people.

16. Statement

All rights of modifying the product are reserved to the manufacturer without further notice. The pictures are only for reference. The final interpretation rights belong to GUILIN WOODPECKER MEDICAL INSTRUMENT CO., LTD. The industrial design, inner structure, etc, have claimed for several parents by WOODPECKER, any copy or fake product must take legal responsibilities.

Scan and Login website
for more information



Guilin Woodpecker Medical Instrument Co., Ltd.
Information Industrial Park, Guilin National High-Tech
Zone, Guilin, Guangxi, 541004 P. R. China
Sales Dept.: +86-773-5873196
[Http://www.glwoodpecker.com](http://www.glwoodpecker.com)
E-mail: woodpecker@glwoodpecker.com



MedNet EC-Rep GmbH
Borkstrasse 10 · 48163 Muenster · Germany

ZMN-SM-407 V1.2-20210331